



**KALASHNIKOV
USA**

**KS-12 SERIES
SEMI-AUTOMATIC SHOTGUN
OWNER'S
MANUAL**



WARNING

READ THE INSTRUCTIONS AND WARNINGS IN THIS MANUAL CAREFULLY AND UNDERSTAND THEM BEFORE USING THIS FIREARM. IF THERE IS ANYTHING YOU DO NOT UNDERSTAND, IT IS YOUR RESPONSIBILITY TO SEEK ADVICE FROM YOUR RETAILER OR A CERTIFIED FIREARMS INSTRUCTOR OR COMPETENT GUNSMITH, OR CONTACT KALASHNIKOV USA AT 754-222-1407 OR CUSTOMERSERVICE@KALASHNIKOV-USA.COM.

Version 3.1

INDEX

WARNINGS	4
ICONS IN OWNER'S MANUAL	5
HAZARDS	5
ILLUSTRATIONS IN OWNER'S MANUAL	5
DANGEROUS PROCEDURES	6
GENERAL SAFETY RULES & PROCEDURES	7
FIREARMS SAFE HOME STORAGE CHECKLIST	13
1. DESCRIPTION AND OPERATION	14
1.1 MODELS	14
1.2 FEATURES	14
1.3 SPECIFICATIONS	15
1.4 COMPLETE SET OF COMPONENTS	15
1.5 DESIGN	15
2. DESIGNATED USE	18
2.1 LIMITATION IN SERVICE	18
2.2 SAFETY PRECAUTIONS	19
2.3 BEFORE USE	19
2.4 OPERATING PROCEDURE	20
3. MAINTENANCE	21
3.1 GENERAL	21
3.2 FIELD STRIPPING	22
3.3 REASSEMBLY AFTER FIELD STRIPPING	26
3.4 CLEANING AND LUBRICATION	27
4. TRANSPORTATION	28
5. STORAGE	28
SCHEMATICS & PARTS LIST	30
WARRANTY	32

**KS-12 SERIES
SEMI-AUTOMATIC SHOTGUN**

OWNER'S MANUAL



KS-12



KS-12T



WARNING!

PRIOR TO REMOVING THIS GUN FROM ITS PACKAGING, AND PRIOR TO HANDLING, LOADING AND FIRING, CAREFULLY AND THOROUGHLY READ AND UNDERSTAND THIS ENTIRE OWNER'S MANUAL WHICH GIVES ADVICE ON THE FIREARM'S PROPER HANDLING, FUNCTIONING AND SAFE USE. YOUR SAFETY AND THAT OF OTHERS (INCLUDING YOUR FAMILY) DEPENDS ON YOUR RESPONSIBLE COMPLIANCE WITH THAT ADVICE, GOOD JUDGMENT AND COMMON SENSE. FIREARMS SAFETY DEPENDS ON YOU. YOU CANNOT FORGET, YOU CANNOT OVERLOOK, YOU CANNOT ALLOW YOURSELF TO BE DISTRACTED, YOU CANNOT BECOME COMPLACENT OR CASUAL WITH FIREARMS. THERE ARE NO "FOOLPROOF" FIREARMS. ONCE A SHOT IS FIRED, IT CANNOT BE CALLED BACK. A FIREARM IN YOUR HANDS CAN CAUSE UNINTENDED DEATH OR SERIOUS BODILY HARM IF YOU FAIL TO FOLLOW SAFE GUN HANDLING RULES AND PRACTICES SUCH AS THOSE CONTAINED IN THIS MANUAL.

REMEMBER, FIREARMS SAFETY DEPENDS ON YOU! IF YOU ARE UNFAMILIAR WITH FIREARMS, SEEK SUPERVISED INSTRUCTION FROM A CERTIFIED INSTRUCTOR.

Important **WARNINGS** and **SAFETY PRECAUTIONS** must be read and understood before using this firearm. **SAFE GUN HANDLING IS YOUR PERSONAL RESPONSIBILITY AT ALL TIMES.** Disregarding the warnings and safety precautions in this manual can result in injury or death to you and others, as well as damage to property.

- Directions and procedures for handling, loading, firing, unloading, disassembling and assembling this firearm.
- Instructions for care, cleaning and repair of this firearm. This OWNER'S MANUAL is designed to help you in learning how to properly and safely use and care for your Kalashnikov USA shotgun. Only when you are certain you have fully familiarized yourself with the function of your firearm, should you practice loading, unloading, and firing with live rounds of ammunition at a firing range or other safe location.

This OWNER'S MANUAL should always accompany the firearm and be transferred with the firearm on change of ownership or possession. Should you ever need to replace it, this manual is available FREE upon request from Kalashnikov USA or on the Kalashnikov USA website at www.kalashnikov-usa.com.

ICONS IN OWNER'S MANUAL

Before you start, familiarize yourself with the icons you will see in the manual.

HAZARDS



DANGER—indicates an imminently hazardous situation which, if not avoided, will result in death or serious injury.



WARNING—indicates a potentially hazardous situation which, if not avoided, could result in death or serious injury.



CAUTION—indicates a potentially hazardous situation or an unsafe practice, which, if not avoided, could result in minor or moderate injury or property damage.

ILLUSTRATIONS IN OWNER'S MANUAL

The illustrations in this manual may differ slightly from the actual product.

The illustrations in this manual relate to the right hand shooter configuration.

DANGEROUS PROCEDURES



WARNING! Always have the headspace checked by a competent gunsmith with “Go” and “No-Go” gauges after replacing the bolt or barrel assembly. Failure to check the headspace may result in personal injury or death to you and others and could cause severe damage to the firearm.



WARNING! If your gun misfires with a live round in the chamber of a hot barrel, immediately remove the round while keeping the barrel pointed in a safe direction and the ejection port turned away from your face. If unable to remove the live round within 10 seconds, remove the magazine, keep the gun pointed in a safe direction, and wait 15 minutes for the barrel to cool. Then remove the round.

Continuous or rapid firing of your gun can cause the barrel temperature to reach a “**COOK OFF POINT**”, where the heat of the barrel can cause a live round to fire from remaining in contact with a hot chamber. If you have been firing continuously or rapidly, do not allow a live round to remain in the chamber when you finish firing, as it may “**COOK OFF**” (FIRE). Always keep your face, hands, and other body parts away from the ejection port when clearing a hot chamber.



WARNING! Never fire your gun with any obstruction in the barrel as this could cause the gun to explode! Be sure the barrel is clear of obstructions before shooting.



WARNING! While firing, if you experience a noticeable difference in sound or recoil, **STOP FIRING!** The cause for either condition could be incomplete powder burn, a cartridge with a primer but no powder (“**SQUIB LOAD**”) or too little powder, and/or a bullet stuck in the bore. Immediately unload the gun and check for unburned powder residue in the bore and the receiver or a bullet stuck in the bore. Remove the unburned powder before resuming firing. If a bullet is stuck in the bore, have a qualified gunsmith take care of the problem. Never try to

“**SHOOT OUT**” a bullet stuck in the bore. Firing with unburned powder in the barrel or a bullet stuck in the bore could cause the barrel to explode causing serious injury or death.

GENERAL SAFETY RULES AND PROCEDURES



CAUTION

CAUTION! The manufacturer of this firearm disclaims any liability for the use of re-manufactured, reloaded or hand-loaded ammunition. Use only factory new, quality ammunition. The use of improper caliber or low quality ammunition could result in injury, death and/or property damage upon firing. Remember, firearms safety depends on you!



WARNING

WARNING! Careless and improper handling of this gun could result in unintended discharge, causing injury, death or property damage. Safety must be the first and constant consideration when handling a firearm and ammunition. **SAFETY DEPENDS ON YOU.**



CAUTION

CAUTION! This firearm was designed to function properly in its original condition. Do not alter any parts. Do not replace any parts unless you are factory-trained to do so and then use only original factory parts from Kalashnikov USA. Any alterations or changes made to a firearm after its manufacture can make the gun unsafe and will void its warranty.



WARNING

WARNING! This firearm should always be carried with the chamber empty and with the safety on “**SAFE**” to prevent accidental discharge.



WARNING! Always handle and treat your firearm as if it were loaded so you will never fire it accidentally when you mistakenly think it is unloaded. Never take anyone's word that it is unloaded. Always check it yourself with your fingers off the trigger and the gun pointed in a safe direction. Even after you have confirmed that the gun is unloaded, continue to treat it as if it were loaded. Never look down a barrel.



WARNING! Do not pull the trigger or attempt to fire until the safety selector has been moved to the **FIRE** position.



DANGER! DO NOT allow any fingers of your non-shooting hand to enter the trigger guard at any time. If you do so, there is a chance your non-shooting hand or fingers could touch the trigger, unintentionally firing the firearm and resulting in death or serious injury.



DANGER! Always keep the safety on "**SAFE**" and your finger outside the trigger area, wrapped around the grip or braced on the gun's receiver, until you intend to fire.



WARNING! All persons present must wear suitable eye and ear protection, and must stand clear of the case ejection area.



WARNING! Keep the gun's muzzle pointed in a safe direction at all times. A safe direction is one in which an unintentionally fired shot will not cause any physical injury or property damage. Never let the muzzle of a firearm point at any part of your body or another person, or in any direction where an injury may result if the gun were to fire. Always be sure of your target and what's beyond and around it before firing.



WARNING! UNLOAD ALL FIREARMS WHEN NOT IN USE. NEVER STORE A LOADED FIREARM. Firearms and ammunition should be stored separately under lock and key so that they are inaccessible to children or unauthorized users. Never leave a loaded firearm, or any firearm or ammunition, unattended where an unauthorized user might have access to it. At the range, any firearm you lay down on the shooting bench should be unloaded, and if possible with its action locked open.

Never let the muzzle of a firearm touch the ground, mud, sand or snow, which might obstruct the bore, causing the barrel to burst when you fire. If you drop a firearm, pick it up carefully with it pointed in a safe direction (have all other people move out of the direction of the muzzle), with your finger outside the trigger area and the safety in the **"SAFE"** position. Then unload the firearm and check to be sure there are no obstructions in the bore. This can be done safely with a cleaning rod, or by disassembling the firearm and looking down the bore from the chamber (rear) end. If there is any possibility of damage to your firearm, have it inspected by a qualified gunsmith, or return it to Kalashnikov USA for inspection, before you load or fire it again.



WARNING! Always make sure your firearm is not loaded before cleaning, storing, transporting or handing it to another person. Firearms should be transported unloaded and in a protective gun case.



WARNING! Whenever you pick up any firearm that, even for an instant, has been out of your direct, continuous control, the first thing you must do, while keeping the muzzle pointed in a safe direction and your fingers out of the trigger area, is to open the firearm's action (mechanism) to determine whether or not it is loaded.



WARNING! Always wear and require others to wear commercially manufactured ear protection when shooting. Without ear protection, the noise from your gun, and other guns close to you, could leave a “ringing” in the ears for some time after firing, and could result in your permanent hearing loss.



CAUTION! Learn the mechanical and handling characteristics of the firearm you are using. Not all firearms are the same, and your Kalashnikov USA firearm has some unique features. Do not assume that just because you have experience with other firearms, you know how to use the Kalashnikov USA firearm properly. Read and understand this manual. If there is anything you do not understand, contact your firearms retailer or Kalashnikov USA at customerservice@kalashnikov-usa.com or telephone 754-222-1407.



WARNING! Do not shoot at a hard surface, such as rock, masonry, metal, water or ice. The projectile may ricochet and travel in unpredictable directions to strike you or another unintended person or object, or even an object that you cannot see.



WARNING! A bullet fired into the air can travel over one mile, and can kill or seriously injure someone when it comes down. Never fire into the air.



CAUTION! Before hunting with this or any other firearm, take an approved Hunter Safety Course, taught in all states by the state game commission or by the National Rifle Association (NRA). Follow your state’s game laws at all times while hunting.



CAUTION

CAUTION! If you have not received formal firearms instruction or if you have any doubts about your ability to handle or use this firearm safely, seek supervised instruction from a certified instructor. Information about sources of firearms instruction can often be obtained from your local police department, firearms retailer, gun club, shooting range, state game commission, or from the National Rifle Association (NRA), 11250 Waples Mill Road, Fairfax, Virginia 22030, telephone 1-703-267-1000 or 1-800-672-3888.



WARNING

WARNING! If at any time you notice something about the appearance or functioning of your Kalashnikov USA firearm that does not seem proper or that causes you concern, **STOP**, unload your firearm immediately, and do not load or fire your firearm until you have it inspected and, if necessary, repaired by a factory-trained armorer, or by Kalashnikov USA. If you fire your Kalashnikov USA firearm extensively, have it professionally inspected and serviced periodically (annually is a good average interval) by a factory-trained armorer or by Kalashnikov USA.



WARNING

WARNING! Firearms and alcohol do not mix. Never drink alcoholic beverages or take drugs before or during shooting. This constitutes criminal disregard for your safety and that of others. Some medications can impair your vision, balance, reflexes, coordination, alertness or judgment. Never use a firearm while you are taking medication unless you have checked with your doctor to ensure you're fit to handle your firearm safely. Do not handle your firearm when you are ill, tired, upset or distracted.



CAUTION

CAUTION! Horseplay has no place around firearms. Guns can't think – you can! **SAFETY DEPENDS ON YOU!**



CAUTION

CAUTION! Remember, safety is your responsibility. Be a safe shooter. **SAFETY DEPENDS ON YOU!**



CAUTION

CAUTION! FOLLOW THE LAW. Obey all local, state and federal laws regarding possessing, storage, shooting and transporting of your firearm.



WARNING

WARNING! Discharging firearms in poorly ventilated areas, cleaning or handling firearms, or handling ammunition may result in exposure to lead and other substances that may cause birth defects, reproductive harm, and other serious physical injury. Have adequate ventilation at all times. Wash your hands and face thoroughly after exposure, and before eating or drinking. Shooting, handling or cleaning firearms may expose you to lead, which is a toxic substance.



WARNING

REMEMBER, FIREARMS SAFETY DEPENDS ON YOU! A SINGLE MOMENT OF INATTENTION OR A SINGLE FAILURE TO FOLLOW THESE GUN SAFETY RULES AND WARNINGS CAN RESULT IN TRAGEDY. YOU ARE RESPONSIBLE FOR THE GUN THAT IS IN YOUR HANDS, IN YOUR POSSESSION, OR UNDER YOUR CONTROL. FIREARMS SAFETY DEPENDS ON YOU!

FIREARMS SAFE HOME STORAGE CHECKLIST

- Firearms naturally attract the attention of children, teenagers and adults alike. Accordingly, it is your responsibility to ensure that your firearms, when unattended, stored, or not in use, are secured under lock and key, safely out of the access of all unauthorized users. This is your responsibility, and any mistake or laziness on your part can result in death or serious injury to your loved ones or others.
- Firearms must be securely stored under lock and key in a location inaccessible to children and other unauthorized persons.
- One of the safest ways to store your firearms is in a locking metal gun safe or lock box. Many models, including ones permitting quick access to the firearm if needed for self-defense, are now available at firearms retailers or via the Internet. Firearms should be unloaded before they are brought into the home and never loaded while in the home.
- Sporting firearms should be immediately cleaned and placed in secure locked storage when they are returned from hunting or target shooting.
- When firearms are removed from storage, they must always immediately be carefully checked to confirm that they are unloaded.
- Ammunition should be stored under lock and key, in a separate location from firearms.
- The OWNER'S MANUAL that came with your firearm must be read, understood and followed.

For more information on safe storage and use, refer to the NSSF pamphlets "Firearms Safety Depends on You" and "Firearms Responsibility in the Home", available for download from the NSSF website at <http://nssf.org>

1. DESCRIPTION AND OPERATION

1.1 MODELS

The various models of Kalashnikov USA semi-automatic shotguns with detachable magazine are available in 12 gauge (hereinafter referred to as the shotgun). Models and specifications are subject to change.



The **KS-12** is a US manufactured 12 GA semi-automatic shotgun based on the Russian Saiga series. It is designed to accept 2.75" and 3" shells and includes a 5 round magazine. The KS-12 has a standard side mounted optics rail, a fixed buttstock and a standard pistol grip with a total length of 38". Most of the currently available Saiga accessories will work on the KS-12 including magazines, drums, muzzle devices and chokes.



The **KS-12T** shotgun is a US manufactured 12 GA semi-automatic shotgun based on the Russian Saiga series. It is designed to accept 2.75" and 3" shells and includes a 10 round magazine. The KS-12T has a 6-position collapsible buttstock, pistol grip, tri-rail forend, standard side mounted optics rail and a flash suppressor. Total length comes to 42.5" with the buttstock fully extended and 38.5" when collapsed. Most of the currently available Saiga accessories will work on the KS-12T including magazines, drums, muzzle devices and chokes.

1.2 FEATURES

Kalashnikov USA shotgun features include:

- Reliable and rugged design of Mikhail Kalashnikov
- US innovation utilizing state of the art manufacturing processes
- Two position safety lever: Fire and Safe
- Front Bead Sight
- Gas piston with rotating bolt lock up design
- Detachable magazine
- No special tools required for field stripping
- Gas Regulation System for heavy and light loads

- Rear V Notch Sight. Windage is adjustable by tapping the rear sight with a rubber mallet
- Threaded muzzle for use with chokes. The muzzle threads are covered by a muzzle nut or flash suppressor depending on model. Thread is M22 x 0.75 6H (Right Hand)



WARNING! Make sure you read and understand the operation and adjustment of the gas regulator. Firing high velocity, high pressure rounds in position "2" may damage your firearm.

1.3 SPECIFICATIONS

GAUGE	LENGTH	OPERATION	FIRE MODE	BARREL LENGTH	SIGHTS
12 GA	2 ¾ " or 3" Magnum	Gas Piston	Semi-Automatic	18 ¼"	Rear Notch/Front Bead

1.4 COMPLETE SET OF COMPONENTS

The shotgun consists of the following main components:

- Barrel With The Receiver
- Bolt & Bolt Carrier
- Gas Piston System
- Trigger And Firing Mechanism
- Gas Tube
- Buttstock
- Handguard
- Pistol Grip
- Magazine
- Receiver Cover

The shotgun components are shown in Schematics. (Pages 30-31)

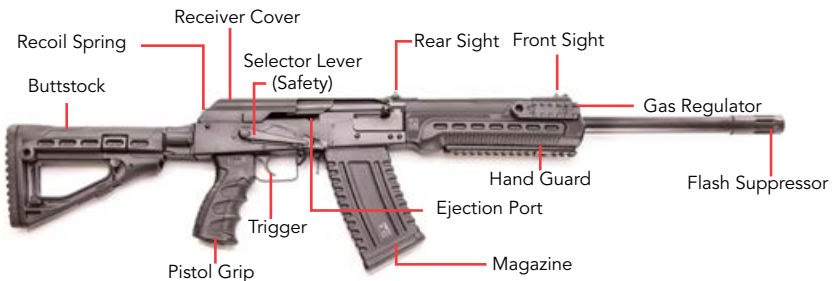

1.5 DESIGN

1.5.1 Details

When the first round is fired, the shotgun automatically reloads using the energy of the gases of the fired round passing from the barrel port into the gas block and then into the gas cylinder forcing the gas piston and

then the bolt carrier to the rear, ejecting the spent shell casing. As the bolt carrier returns to the forward position using the energy of the recoil spring, the next shell is picked up from the magazine and is positioned into the breach of the barrel, ready to be fired when the trigger is pulled again.

In addition, the firearm can be cycled by hand (with a magazine in the magazine well) by retracting the bolt carrier to the rearmost position by hand and utilizing the energy of the recoil spring to pick up the shell from the magazine and position it in the breach of the barrel.

The bolt rotates around its axis as the bolt carrier moves along the receiver rails. When in battery, the bolt is locked in place with two locking lugs.

The trigger and firing mechanism utilizes a hammer type design to ensure single-shot firing and a trigger blocking device when the safety lever is set at the safe position to prevent firing.

The magazine is released by the force of gravity while pressing the magazine latch forward.

1.5.2 Gas Management System

Your KS-12 Shotgun is equipped with a manual gas regulation system. Your gas regulation system allows your KS-12 to accommodate a wider variety of loads such as Lower Recoiling Target and Small Game loads, or Higher Recoiling loads such as Magnum loads or Slug and Buckshot depending on gas setting. You **MUST** adjust the regulator to match the ammunition or you will experience functional issues and risk premature component failure.

1.5.3 How to use your Gas Management System

Located in the front of your gas block is your gas regulator (Part #9). As outlined in Section 3.2.2 use your supplied tool as instructed to depress gas regulator detent and to adjust regulator. Be sure your regulator is as fully threaded into the gas block as possible without being tightened into the gas block. Once the regulator is bottomed out on the gas block, release the regulator detent and reverse regulator until it locks into the setting you wish to use. Depress detent and adjust as needed keeping the regulator as threaded into the gas block as possible. **(Sometimes the regulator will stop on the desired setting. If so, it is not needed to back it off).**

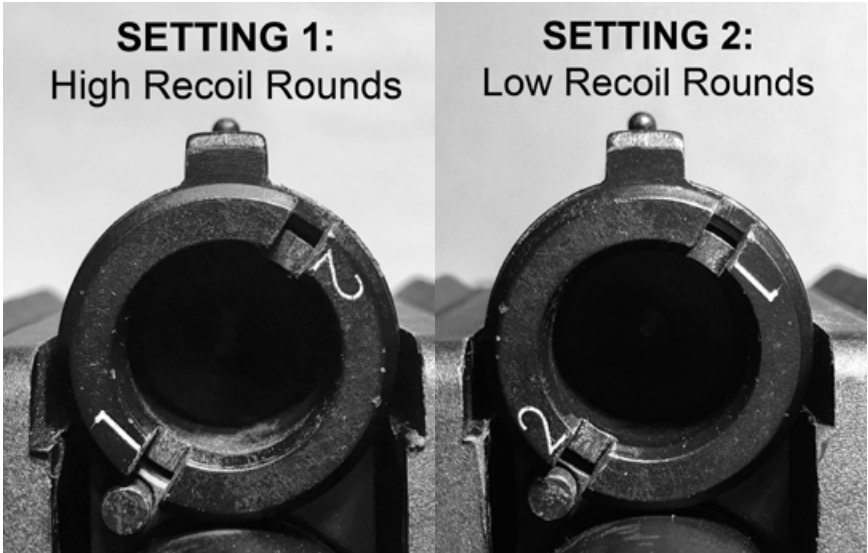

1.5.4 Understanding your Gas Management Settings

Your KS-12 shotgun's gas regulator serves to control flow of gas into the action of your shotgun. Permitting full gas or restricting gas. (**Suggestion: Test all new loads under setting 1. If they do not cycle, use setting 2.**)

- **Gas Setting 1:** Restricts gas into the action. Ideal for heavier recoiling loads such as Magnum loads or Slug and Buckshot. Setting 1 will limit the amount of gas into the system and avoid wear and tear on your shotgun from the energy of heavier loads.
- **Gas Setting 2:** Permits full gas into the action. Ideal for lower recoiling loads such as light birdshot or target loads. This setting permits the full flow of gas into the action to aid in cycling of the system for weaker loads. **DO NOT** use setting 2 for heavy loads! Never shoot 3" Magnum shells in setting 2. Never shoot any high velocity or magnum loads in setting 2.

1.5.5 Gas System Maintenance

Due to the wide verity of loads available in shotshells the use of some loads require more frequent cleaning. Neglecting to maintain your gas system may cause premature failure to your KS-12 as pressures in your gas system can increase if they system is not cleaned. It is advised to keep your gas system clean as often as you can. When using slug rounds its advised to practice cleaning every 40 rounds, as slugs foul the system with buildup faster. Other loads such as target/small game loads can permit more time in between cleaning periods.

1.5.6 Cleaning your Gas System

Make sure your firearm is unloaded. Remove the magazine and check the action to make sure there is no round in the chamber. Then field strip your KS-12 as shown in section 3.2 of the owner's manual. Next, using the supplied tool, depress gas regular detent on the gas block and unscrew the regulator to remove. Once removed, insert a cleaning rod from the opposite side and push the gas puck (Part #8) until it is free from the gas block.

Once disassembled, use a brass bristle brush or 12ga brass bristle bore brush to break up fouling build-up in gas block. For stubborn buildup, use a conservative amount of cleaning solvent and a brass brush. Perform the same cleaning procedure to the puck (Part #8), gas regulator (Part #9), as well as the gas piston on the bolt carrier (Part #13). Once cleaning is complete, remove any solvents from the surfaces and components. Be sure not to lube any component in your gas system.

- (Recommendation: To aid in removal of the gas regulator, maintain a light coat of anti-seize only on the threaded portion of the regulator.

1.5.7 Reassembly

Simply reverse take-down process: Insert the puck (Part #8) into the gas block and thread the regulator (Part #9) into the gas block while keeping the plunger depressed. Thread the regulator all the way down until it stops, then back off to the setting for the shot shells you will use. (Sometimes the regulator will stop on the desired setting, if so it is not needed to back it off).

.....

2. DESIGNATED USE

2.1 LIMITATIONS IN SERVICE



WARNING

2.1.1 WARNING! Before using the shotgun, read and understand all of the warnings in this manual.

2.1.2 Read and understand this OWNER'S MANUAL completely.



CAUTION

2.1.3 CAUTION! Study the shotgun design. Paying special attention to all the safety precautions.



CAUTION

2.1.4 CAUTION! Use only new, unexpired, factory ammunition in the shotgun. The use of reloaded or expired ammunition will void the warranty.



WARNING

2.1.5 WARNING! Always use protective shooting glasses and hearing protection.

2.2 SAFETY PRECAUTIONS



CAUTION

CAUTION! The KS-12 design ensures its safe functioning providing proper rules of operation are adhered to and the correct gas regulation setting is used for your chosen ammo.

To ensure safe handling of the shotgun follow all safety precautions listed in this manual:

- ALWAYS treat all firearms as if it is loaded.
- ALWAYS keep all firearms pointed in a safe direction.
- ALWAYS keep your finger off the trigger until ready to shoot.
- Know your target and what is beyond it.
- Keep the safety lever engaged when not firing to prevent an accidental discharge.
- In a safe direction, verify the magazine and the chamber are empty, disengaging the safety, retracting the bolt carrier and inspection the magazine and chamber.
- Before loading the shotgun, inspect the barrel bore and the chamber to be certain they are free of any obstruction.
- In case of a misfire, don't open the bolt for 3 (three) minutes to prevent the possibility of hangfire.
- Always keep the safety lever engaged to prevent an accidental discharge.
- Empty the magazine and chamber before leaving the shooting area and before entering an inhabited area, before entering a vehicle, and when crossing forests, rough terrain, water, etc.
- Store the shotgun and ammunition separately and beyond the reach of children and strangers.
- Only use new, unexpired, factory loaded ammunition. Do not use reloaded ammunition or any ammunition with traces of corrosion.

2.3 BEFORE USE



CAUTION

2.3.1 CAUTION! Before operating the shotgun you must familiarize yourself with all the warnings in this manual.

2.3.2 Verify the firearm is unloaded. Remove the magazine. Inspect the magazine well and chamber to make sure there is no ammunition in the firearm.

Before using or loading ammunition in the shotgun always:

- Wipe the barrel bore and chamber, muzzle chokes and gas chamber dry to remove any grease or fouling.
- Verify the hand guard screw is secured to the forend.
- Check the trigger mechanism and safety for proper functioning.

- Verify the attached magazine is securely held in place by the magazine release.
- Pull the bolt carrier handle fully to the rear and release it to check the shotgun for proper functioning.
- Make sure the gas regulator is properly set to the ammunition you are going to use.

2.4 OPERATING PROCEDURE

2.4.1 Engaging and Disengaging the safety

2.4.1.1 Engage the safety – move the safety upwards to the “S” (Safe) position.

2.4.1.2 Disengage the safety – move the safety downwards to the “F” (Fire) position. The shotgun will now fire if the trigger is depressed.

2.4.1.3 There is a notch in the safety lever that is used to hold the bolt carrier handle in the bolt open position. The bolt hold open feature aids in magazine changes and to show the action is open and safe.

2.4.2 Loading and firing procedure:

- Pull the bolt carrier handle rearward and engage the handle into the notch in the safety lever. This will hold the bolt in the rearward position.
- The shotgun is designed to fire both 12 gauge 2 ¾” and 3” “Magnum” shotgun shells with proper gas regulator adjustment.
- Press the magazine release and detach the magazine from the shotgun by rotating bottom portion forward.
- Load the magazine with the correct ammunition, feeding them one by one from the front of the magazine and under the magazine lips and moving each of them rearward till the rounds stop against the rear wall of the magazine.
- With the bolt hold open by means of the safety lever or manually holding bolt open, attach the loaded magazine to the shotgun by first positioning the lip on the front edge of the magazine into the magazine well and then swing the magazine back and upwards until the magazine latch catches under the lip at the rear of the magazine.
- When ready to fire, disengage the safety; **Always keeping your fingers or any object away from the trigger and outside the trigger guard.**
- The bolt will move forward under spring tension, pick up a cartridge and load it into the chamber. Move the safety lever to “S” until ready to ready to fire.



CAUTION

To fire, move the safety lever to “F”.

The shotgun is loaded and is ready for firing.

Aim, pull the trigger and the shotgun will fire.

To fire the next shot from the auto-loading shotgun release the trigger and depress it again.



CAUTION

NOTE: When the magazine is depleted, the bolt carrier and bolt will return to the forward position. You may pull the carrier handle rearward and engage the handle with the notch in the safety lever to keep the bolt carrier rearward and ensure the chamber is empty.

2.4.3 Unloading procedure:

- Make sure the muzzle of the barrel is pointed in a safe direction.
 - Engage the safety.
 - Detach the magazine.
 - Disengage the safety.
 - Move the bolt carrier rearward. Engage the safety and make sure the bolt carrier handle is inside the notch in the selector lever to lock it in the rearward position.
 - Visually inspect the magazine well and chamber for ammunition.
 - Extract ammo from the chamber and magazine well (if necessary).
 - Empty the cartridges from the magazine.
-

3. MAINTENANCE

3.1 GENERAL

3.1.1 Maintenance consists of inspection, cleaning and lubrication of the shotgun during field stripping or disassembly. The field stripping of the shotgun is carried out for its inspection, cleaning and lubrication after firing.



DANGER

3.1.2 DANGER! BEFORE BEGINNING DISASSEMBLY, MAKE SURE THAT THE SHOTGUN IS UNLOADED. With the shotgun pointed in a safe direction, detach the magazine, disengage the safety, retract the bolt carrier & bolt using the bolt-carrier handle, examine the chamber and magazine well to make sure that it is empty, and finally move the bolt carrier and bolt into battery (forward position).

3.1.3 Disassemble and assemble the shotgun on a table or clean canvas. When placing the parts and components down arrange them in the sequence of removal, handle the detached parts with care, do not put one part on another, and when removing them, avoid excessive effort and sharp blows.



CAUTION

3.1.4 CAUTION! ONLY USE RECOMMENDED OR KNOWN CHEMICAL AGENTS FOR CLEANING AND LUBRICATION OF THE SHOTGUN. UNKNOWN OR NON-RECOMMENDED CHEMICAL AGENTS MAY BE DANGEROUS FOR YOU AND DAMAGE THE SHOTGUN PARTS AND COMPONENTS.

3.2 FIELD STRIPPING



Figure 3.1 — Detaching The Magazine

3.2.1 Field Stripping Procedure

- Make sure the firearm is unloaded and there are no rounds in the magazine or chamber. Move the safety lever to "S" or safe position.
- Detach the magazine as shown in Figure 3.1. Hold the shotgun by the forend with one hand, grip the magazine with the other hand and depress the magazine latch with a thumb in the direction of the magazine, push the lower portion of the magazine forwards and detach it.



Figure 3.2 — Detaching The Receiver Cover

- Remove the receiver cover, as shown in Figure 3.2. Hold the rear portion of receiver cover with one hand, and hold the buttstock with your other hand. Using the hand holding the rear of the receiver

push the exposed plunger of the recoil spring guide down and push forward the recoil spring guide into the receiver as you pull the cover up to separate the cover from the recoil spring guide.

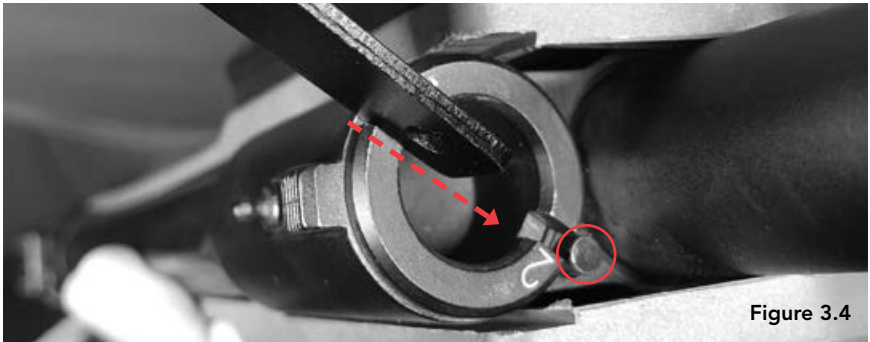

3.2.2 Removing Gas Regulator & Gas Piston Puck

Using the handle (rear portion) of your supplied tool, in a perpendicular angle to the shotgun (As seen in Figure 3.3 & 3.4) depress gas regulator (Part #9) detent with tool at the same time using the tool in the notches in the regulator to begin the unscrewing process going in a counter-clockwise rotation. (While trying not to make contact with tool to barrel as this will scratch the finish). Continue until the regulator is past the reach of the detent. After which, simply unscrew until free from gas block. Once removed, insert a cleaning rod from the opposite side of gas tube/block and push the gas piston puck (Part #8) until it is free from the gas block. Light tapping of puck may be necessary at times.



Figure 3.5

Figure 3.5 — Detaching The Recoil Spring Guide Assembly

- Detach the recoil spring guide assembly from the receiver as shown in Figure 3.5. Push the recoil spring guide forward 1" until the guide is out of the receiver end slot of the rear trunnion and extract the recoil spring assembly from the receiver and the bolt carrier channel, moving it up and to the rear.



Figure 3.6

Figure 3.6 — Detaching The Bolt Carrier And The Bolt

- Remove the bolt carrier and the bolt as shown in Figure 3.6. Move the safety lever to the "F" (Fire) position, keeping your fingers away from the trigger area. Retract the bolt carrier until it is at the rear of the receiver, lift it up until it is just out of the receiver and then to the rear to allow the gas piston to come out of the gas tube and remove the bolt carrier and bolt as one unit.



Figure 3.7 — Detaching The Bolt From The Bolt Carrier

- Separate the bolt from the bolt carrier. Hold the bolt and the bolt carrier with one hand, as shown in Figure 3.7, turn the bolt head counterclockwise with your other hand. As the bolt turns counterclockwise it will also move to the rear of the bolt carrier. After the bolt travels about 1" rearward (and while the bolt rotates counterclockwise) you will be able to continue to rotate the bolt counterclockwise without it moving any further rearward as the bolt lug is now disengaged from the shaped slot in the bolt carrier and by moving the bolt forwards (without turning it) the bolt can be removed from the bolt-carrier channel.

3.2.3 Detach the Gas Regulator

- Push in the spring loaded gas regulator plunger using included tool and unscrew the gas regulator counter-clockwise.
- Remove the gas puck per instructions in Section 1.5.6.

3.3 REASSEMBLY AFTER FIELD STRIPPING

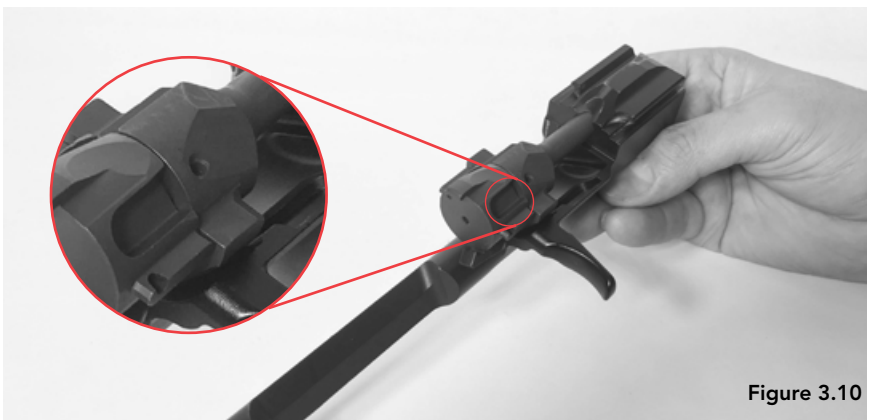
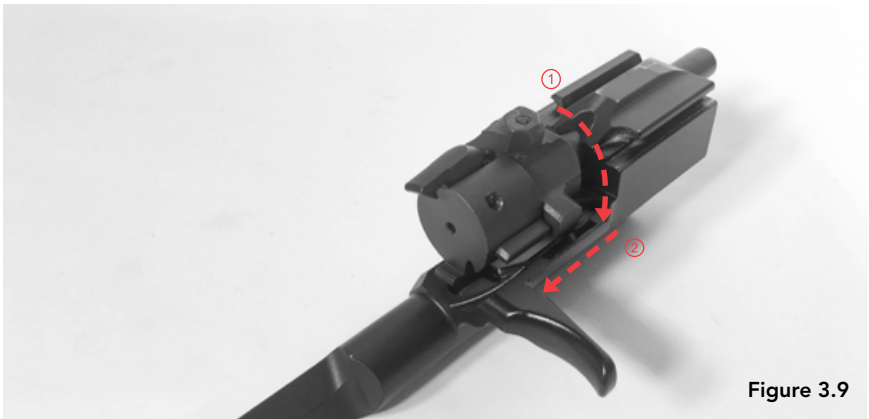

Reassemble in the reverse order as follows:

- Insert the gas puck into the gas chamber.
- Push in the gas regulator detent using a supplied tool and insert

the gas regulator into the gas chamber and screw it in until it rests against the gas block face. Then unscrew the gas regulator until the first fixed position for the mode of firing determined by the type of ammunition you have selected. See Section 1.5.4 for further details regarding your gas management system.

- Attach the bolt to the bolt carrier. Insert the bolt into the bolt carrier channel and turn it so that its guiding lug enters the groove slot of the bolt carrier, then move the bolt forward until it stops.
- Before putting the bolt carrier with bolt into the receiver make sure that the hammer is engaged with the trigger-mechanism (trigger hook). If the hammer is not engaged, using your finger, push the hammer to the rear and down until it engages the hook.
- Insert the bolt carrier guide lugs into the receiver guides, and move the bolt carrier assembly forward.



WARNING! WHEN ATTACHING THE BOLT CARRIER ASSEMBLY TO THE RECEIVER VERIFY THE SLOTS FOR THE EJECTOR ON THE BOLT AND THE BOLT HEAD ARE ALIGNED.

- Insert the recoil spring guide assembly into the bolt carrier slot and insert the recoil spring guide base into the rear trunnion grooves. Insert the cover by its front face into the semicircular notch on the front trunnion and press the rear of the cover down so the lug of the recoil spring guide assembly enters the rectangular hole in the receiver cover.
- Return safety lever to "S" (Safe) position.

3.4 CLEANING AND LUBRICATION

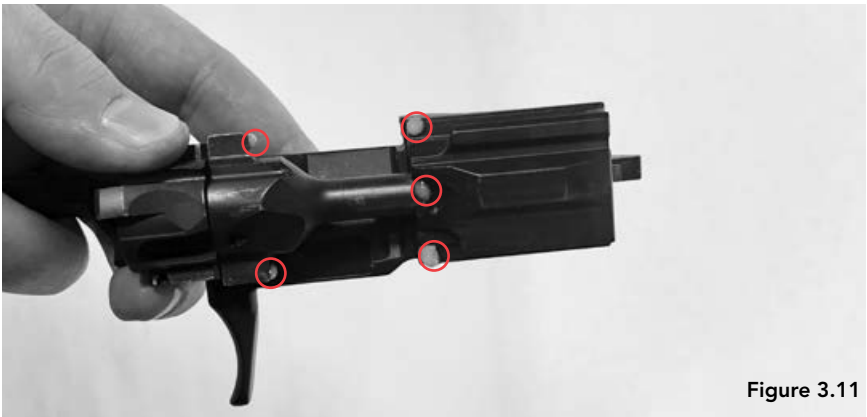

Figure 3.11

3.4.1 Cleaning and Lubrication

Your firearm should be cleaned after each use.

The cleaning process follows:

Make sure your firearm is unloaded before cleaning. In a well ventilated area, use a cleaning rod with a 12 gauge bore-brush attached. Apply bore cleaner to the brush and run it through the barrel a few times to remove fouling. Next, remove the brush and attach a patch holder to the rod. Thread a patch through the slot in the holder and apply bore cleaner. Run the patch through the barrel, replacing the patches until they come out clean. With a new patch, apply a few drops of quality gun oil and run through barrel one more time.

Clean the other components as needed to remove carbon deposits and finish with a light coat of oil. Pay special attention to keeping the gas system clean. See section 1.5.6 for detailed instructions.

Minimal cleaning areas:

Wipe the clean area where the bolt carrier and bolt interface with each other along with the receiver. Paying extra attention to the rails of the receiver, front trunnion bolt lug slots, receiver rail slots in the bolt carrier and all of the bolt assembly.



CAUTION

3.4.2 Lubing

It is recommended to only use a small drop of oil in these 5 key locations (See Figure 3.11). With the bolt in the carrier, lube both rail slots, back of locking lugs of the bolt, and finally the hammer ridding surface of the bolt carrier. **(NOTE: Be sure not to lube components in the gas block).**

4. TRANSPORTATION

4.1 Transport the unloaded, locked shotgun in a carrying case to protect it from shocks and drops.

4.2 You may use a sling to carry the shotgun while hunting. The shotgun is carried with the magazine attached and the safety selector lever on safe, or action locked open.

5. STORAGE

5.1 Store the shotgun for no longer than 12 months without re-preservation (shorter periods in damp, cold or humid environments).

5.2 Store the shotgun in dry premises without sharp temperature fluctuations, away from heating devices. The shotgun should be always unloaded, the magazine detached, and the safety should be in the "S" (Safe) position. The shotgun should be cleaned and lubricated before

storage. Store in an appropriate gun safe or with a cable lock inserted through the magazine well and out of the ejection port.

SCHEMATICS

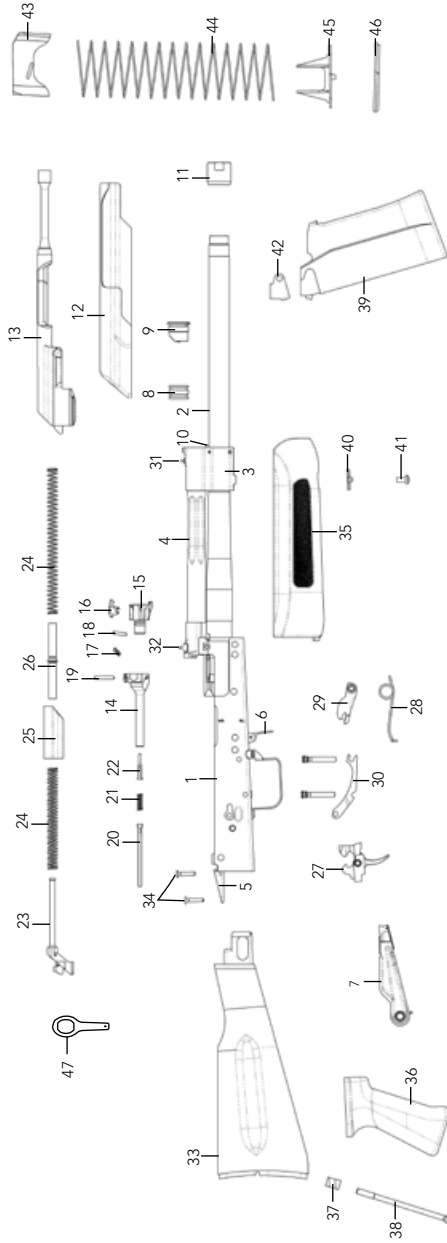

PARTS LIST

BARREL WITH RECEIVER

- 1 — RECEIVER
- 2 — BARREL
- 3 — GAS BLOCK
- 4 — GAS TUBE
- 5 — REAR TRUNNION
- 6 — MAGAZINE CATCH
- 7 — SAFETY SELECTOR LEVER
- 8 — GAS PISTON PUCK
- 9 — GAS REGULATOR
- 10 — GAS REGULATOR PLUNGER
- 11 — MUZZLE NUT
- 12 — RECEIVER COVER

RECOIL SPRING GUIDE ASSEMBLY

- 23 — RECOIL GUIDE ASSEMBLY
- 24 — RECOIL SPRING
- 25 — EJECTION PORT COVER
- 26 — FRONT RECOIL SPRING GUIDE

- 39 — MAGAZINE
- 40 — HANDGUARD BASE
- 41 — HANDGUARD SCREW

MAGAZINE

- 42 — FEED LIPS
- 43 — FOLLOWER
- 44 — SPRING
- 45 — BASE PLATE LOCK
- 46 — COVER

TRIGGER AND FIRING MECHANISM

- 27 — TRIGGER GROUP
- 28 — HAMMER SPRING
- 29 — HAMMER
- 30 — TRIGGER AXIS PIN LOCK

TOOLS

- 47 — WRENCH

BOLT CARRIER WITH BOLT

- 13 — BOLT CARRIER
- 14 — BOLT
- 15 — BOLT HEAD
- 16 — EXTRACTOR
- 17 — EXTRACTOR SPRING
- 18 — EXTRACTOR PIN
- 19 — BOLT HEAD PIN
- 20 — FIRING PIN ROD
- 21 — FIRING-PIN SPRING
- 22 — FIRING PIN

IRON SIGHTING DEVICE

- 31 — FRONT SIGHT
- 32 — REAR SIGHT

FURNITURE

- 33 — BUTTSTOCK
- 34 — BUTTSTOCK SCREWS
- 35 — LOWER HANDGUARD
- 36 — PISTOL GRIP
- 37 — PISTOL GRIP NUT
- 38 — PISTOL GRIP SCREW

WARRANTY

KALASHNIKOV USA LIMITED WARRANTY:

Kalashnikov USA firearms are manufactured to the highest quality standards. Each firearm is tested and the quality is assured before the firearm leaves the factory.

This limited warranty has been drafted in compliance with Magnuson-Moss Warranty Federal Trade Commission Improvement Act, which is effective for goods manufactured on or after December 31, 1975.

All firearms manufactured by Kalashnikov USA have a limited 2 year warranty to the original purchaser. Original retail purchase date is verified by your sales receipt and ATF Form 4473.

This warranty does not cover:

- **DAMAGE TO THE FIREARM CAUSED BY FAILURE TO PROVIDE PROPER CARE, STORAGE AND MAINTENANCE.**
- **ACCIDENTS, MISUSE, NEGLIGENCE, ABUSE OR UNREASONABLE USE.**
- **USE OF THE FIREARM WITH HAND LOADED, RELOADED, DEFECTIVE OR IMPROPER AMMUNITION.**
- **DAMAGE CAUSED BY BARREL OBSTRUCTION.**
- **UNAUTHORIZED ADJUSTMENT, DISASSEMBLY, REPAIRS, OR MODIFICATIONS.**
- **DAMAGE CAUSED BY FIRING HIGH ENERGY ROUNDS WITH THE GAS REGULATOR IN THE POSITION DESIGNED FOR LIGHT LOADS.**
- **NORMAL WEAR AND TEAR, INCLUDING BARREL BORE WEAR OR CORROSION.**
- **FINISH OR SURFACE COATINGS.**
- **PHYSICAL INJURY OR PROPERTY DAMAGES RESULTING IN WHOLE OR IN PART FROM CRIMINAL USE OR NEGLIGENT, IMPROPER USE OR CARELESS HANDLING.**
- **LOSS OR DAMAGE OCCURRING DURING RETURN SHIPMENT.**
- **THIS WARRANTY DOES NOT COVER SECOND AND SUBSEQUENT OWNERS OF THIS FIREARM.**

If you discover a defect during the warranty period, Kalashnikov USA will, at its option, repair or replace the firearm with a comparable firearm at no charge. A service or handling charge may be required for non warranty repairs.

Kalashnikov USA excludes and will not pay incidental or consequential damages with respect to economic loss, injury or property damage resulting from the breach of either the express or implied warranty. No implied warranties extend beyond the term of this written warranty. Please note: Some jurisdictions do not allow exclusion of incidental or consequential damages, or limitation on how long an implied warranty lasts. Thus the above exclusion and limitations may not apply to you. This warranty gives specific legal rights to the original retail purchaser only. Other rights may apply and vary from state to state. The terms of this warranty can only be changed by an authorized officer of Kalashnikov USA.

If you have any questions, concerns or service or warranty issues please contact our customer service department at 754-222-1407 or e-mail customerservice@kalashnikov-usa.com. Customer service will provide shipping instructions.

All returns require a RMA # and must follow the shipping instructions. Do not ship firearms without a RMA #. **FIREARMS MUST BE UNLOADED. AMMUNITION MUST NOT BE SHIPPED WITH THE FIREARM. PACK THE FIREARM SECURELY.** The sender must prepay freight. We will not accept C.O.D. shipments.

If you do not have an owner's manual, please download it from our website.

This product can expose you to chemicals including lead, which is known to the State of California to cause cancer and birth defects or other productive harm. For more information go to www.p65Warnings.ca.gov

Your Kalashnikov USA firearm comes standard (USA only) with a cable lock (Figure 6.1). The cable must be placed through the ejection port and out of the magazine well. Insert the end of the cable into the lock and make sure it is locked into place.



Figure 6.1

NOTES

